

CRYSTORAMA

LIGHTING THE WAY FOR SIXTY YEARS

ASSEMBLY INSTRUCTION MODEL #138-VG



All electrical components must be installed by a licensed electrician in accordance with the National Electric Code and the appropriate local electrical codes.



You will need 6- Candelabra Base Bulb
40 Watts Recommended 60 Watts Max.
USE LED BULBS FOR EXTENDED USE
This fixture is Damp rated

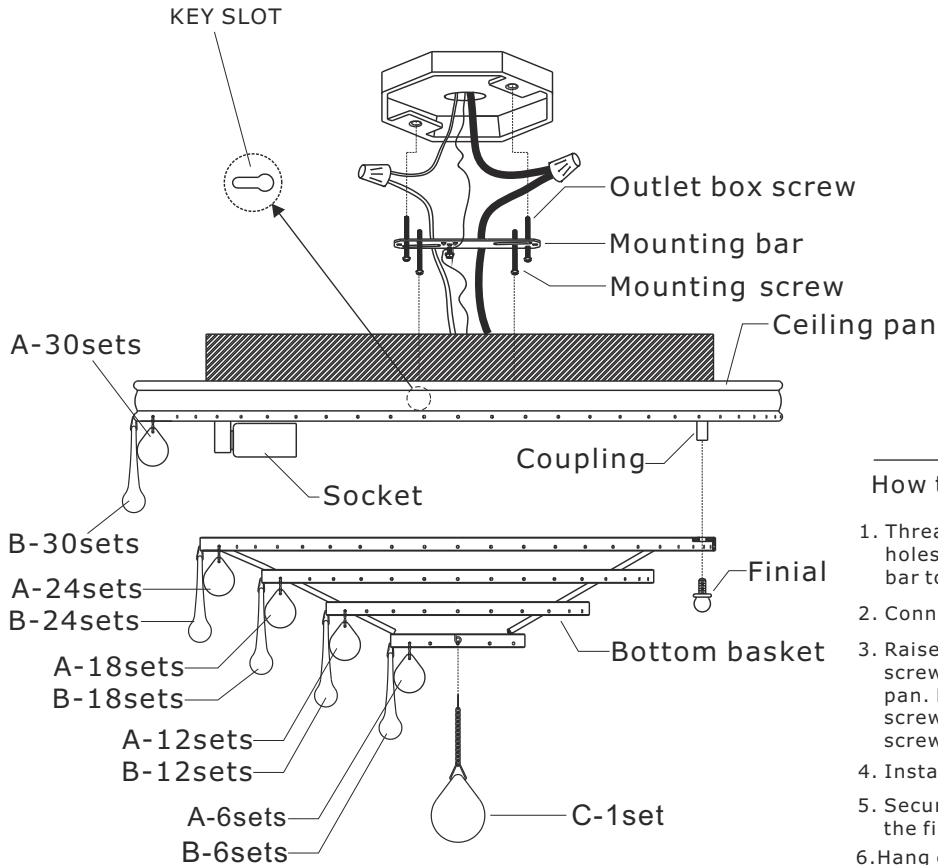

Hang crystals on the rings alternating between crystals A and B

How to install

1. Thread the mounting screws into the matching holes in the mounting bar. Secure the mounting bar to outlet box with the outlet box screws.
2. Connect fixture wires to supply wires in outlet box.
3. Raise ceiling pan up allowing for the mounting screws to protrude through key slots on the ceiling pan. Rotate ceiling pan clockwise until mounting screws are in narrow part of key slots, tighten with screwdriver.
4. Install the bulb(not included) into the socket.
5. Secure the bottom basket to the ceiling pan with the finial.
6. Hang crystals to the ceiling pan and bottom basket, alternating between glass drop A and B.
7. Hang glass drop C at the bottom of the bottom basket.

A= 40mmx90sets

B= 76mmx90sets

C= (40mm Ball with chain)x1set

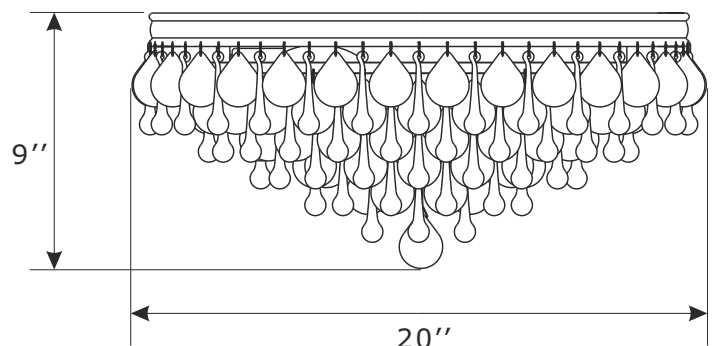

WARNING: This product can expose you to Lead which is known to the state of California to cause cancer and/or birth defects or reproductive harm. For more information go to www.P65Warnings.ca.gov

CRYSTORAMA

LIGHTING THE WAY FOR SIXTY YEARS

ASSEMBLY INSTRUCTION MODEL #138-VG

Part Number

Part Numbers

- A. (1)-Mounting hardware
- B. (1)-Ceiling pan
- C. (6)-Socket
- D. (1)-Bottom basket #XRF138VGBT
- E. (3)-Finial #XRF138VGFIN

